

RX 60 Technical Data Electric Forklift Truck

[RX 60-35 \(Plus\)/600|Li-Ion](#)

[RX 60-40 \(Plus\)|Li-Ion](#)

[RX 60-40 \(Plus\)/600|Li-Ion](#)

[RX 60-45 \(Plus\)|Li-Ion](#)

[RX 60-45 \(Plus\)/600|Li-Ion](#)

[RX 60-50 \(Plus\)|Li-Ion](#)

[RX 60-50 \(Plus\)/600|Li-Ion](#)



RX 60-35/50 Electric Forklift Truck

Technical Drawings

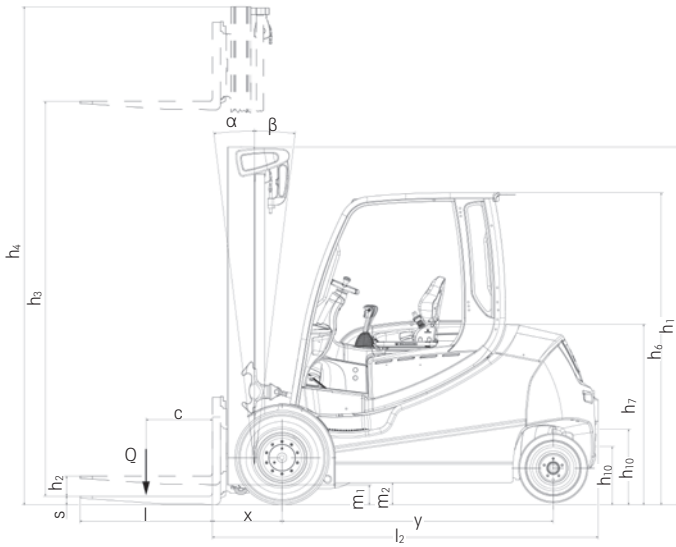

Side view

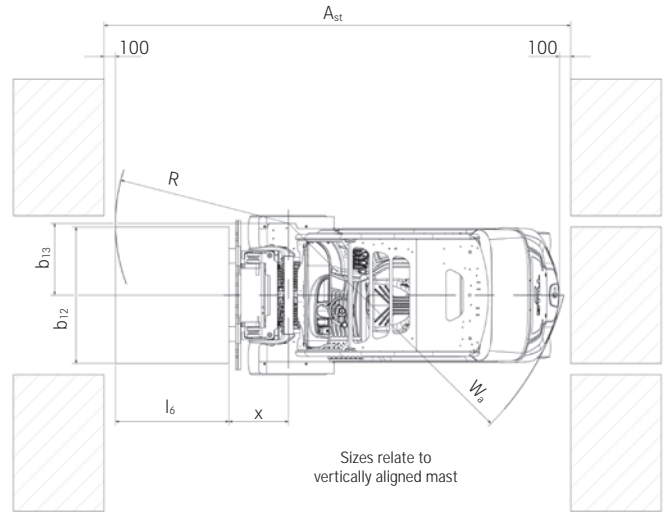

Top view

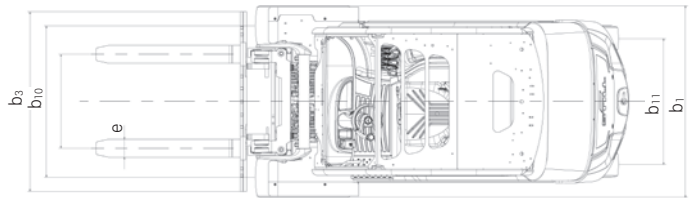

Top view

Gradients

Maximum distance that can be driven in 60 minutes.

Example: with a load of 4,000 kg and a gradient of 7%, an RX 60-40 (standard performance) can drive a distance of 460 m up to ten times per hour.

Standard performance		Gradient	Maximum distance in m						
			RX 60-35/600	RX 60-40	RX 60-40/600	RX 60-45	RX 60-45/600	RX 60-50	RX 60-50/600
With load		13%	1193	802	620	294	280	269	255
		9%	3396	2754	2520	2234	1850	1680	1545
		7%	5520	4600	4320	3563	2910	2410	2150
		5%	7535	6300	6189	5850	5795	5736	5449
Without load		23%	328	328	311	311	276	276	259
		20%	1250	1250	1155	1155	487	487	411
		15%	2779	2779	2560	2560	2107	2107	1795
		10%	7402	7402	6664	6664	5374	5374	4953
		5%	14384	14384	14000	14000	13773	13773	12913
*Plus performance		Gradient	Maximum distance in m						
			RX 60-35/600	RX 60-40	RX 60-40/600	RX 60-45	RX 60-45/600	RX 60-50	RX 60-50/600
With load		13%	1330	869	429	409	405	380	282
		9%	4390	3214	2987	2850	2320	2158	1789
		7%	7420	6120	5136	4900	4212	3922	3483
		5%	10901	10780	10639	10150	8130	7890	7875
Without load		23%	407	407	415	415	380	380	340
		20%	1982	1982	980	980	515	515	442
		15%	4363	4363	3800	3800	2574	2574	1896
		10%	9812	9812	9333	9333	7400	7400	6800
		5%	14384	14384	14000	14000	13773	13773	12913

Dry rough concrete = coefficient of friction 0.80

Battery: standard as per specification sheet

Speed is variable

*Plus performance = high performance variant

RX 60-35/50 Electric Forklift Truck

Detailed Photos



Full cab for outdoor use in all weathers



Optimum availability due to fast and safe battery change



Slim mast ensures excellent view of the forks and extremely high safety standards



Optional air conditioning ensures a pleasant atmosphere in the workplace



Fatigue-free work thanks to the spacious driver's workplace



Telescopic mast for outstanding visibility ahead



High level of safety thanks to large, non-slip steps for easy entry



Safe, intuitive operation with the STILL Easy Control display and control module

RX 60-35/50 Electric Forklift Truck

Basic Load Capacities

RX 60-35/600 Telescopic mast/single SE tyres

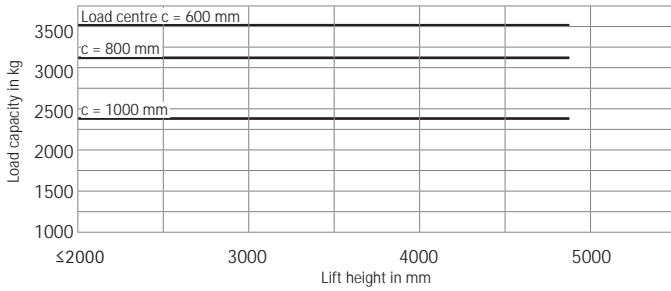

RX 60-35/600 Triplex mast/single SE tyres

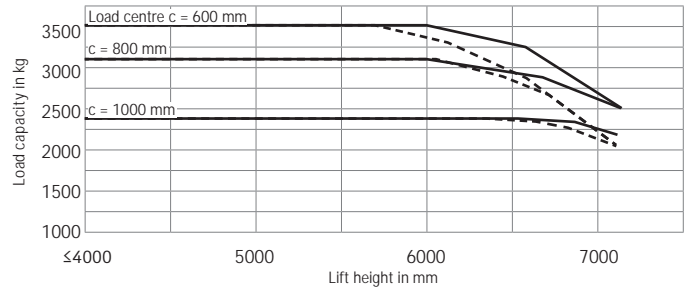

RX 60-40 Telescopic mast/single SE tyres

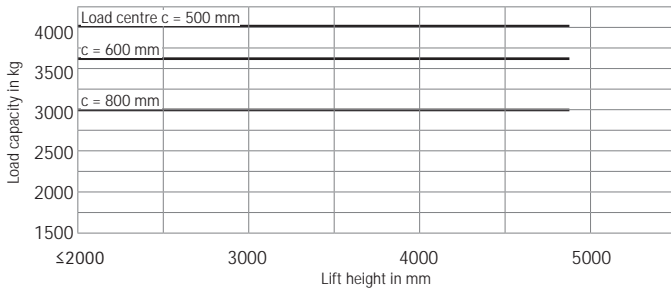

RX 60-40 Triplex mast/single SE tyres

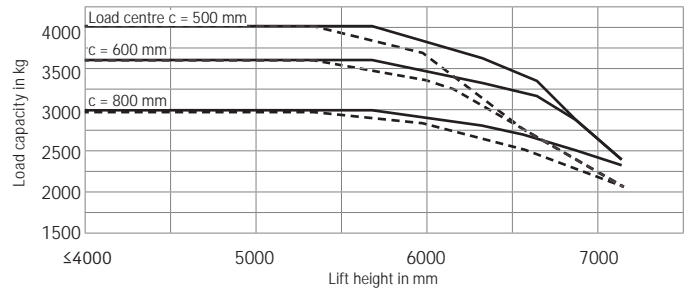

RX 60-40/600 Telescopic mast/single SE tyres

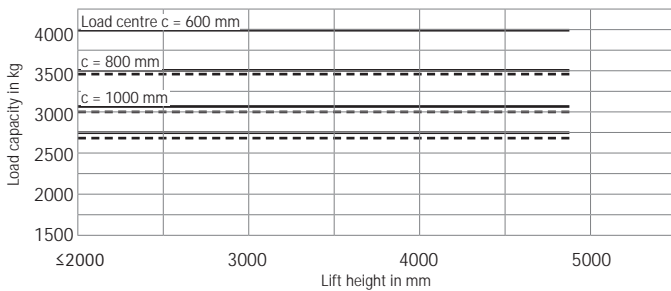

RX 60-40/600 Triplex mast/single SE tyres

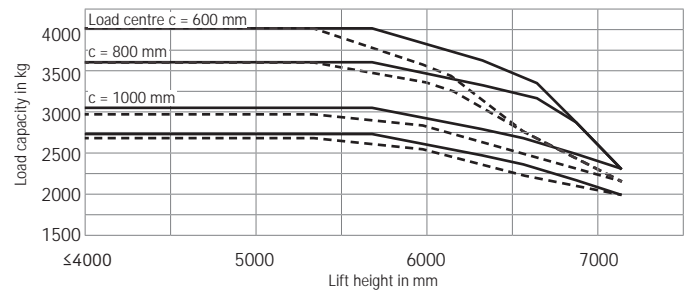

RX 60-45 Telescopic mast/single SE tyres

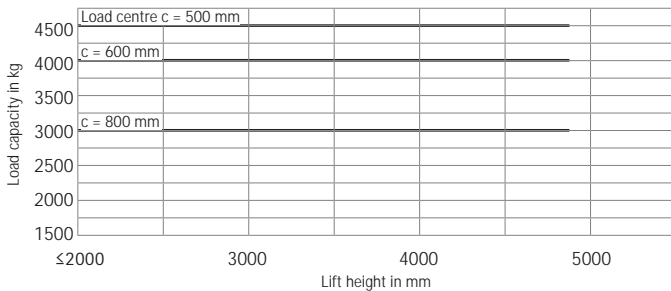

RX 60-45 Triplex mast/single SE tyres

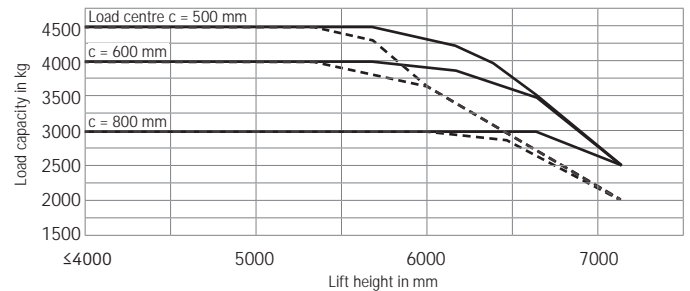

RX 60-45/600 Telescopic mast/single SE tyres

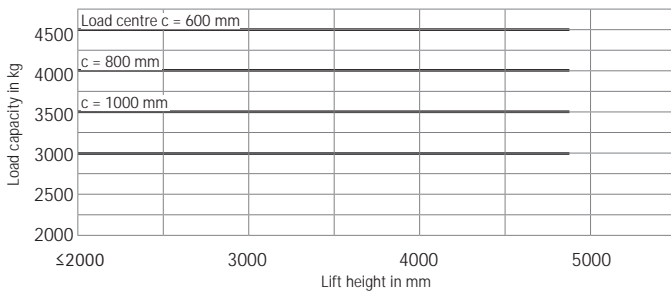

RX 60-45/600 Triplex mast/single SE tyres

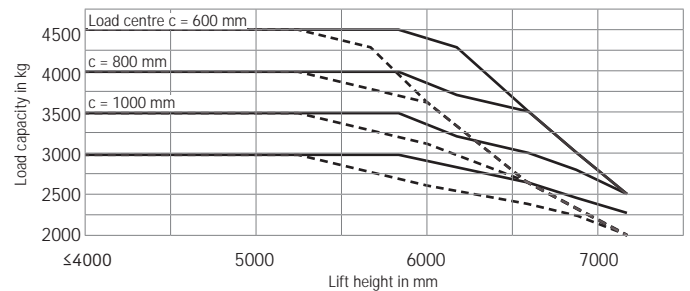

— with standard forks - - - with integrated side shifter and standard forks
 The listed values may vary depending on the truck's features.

RX 60-35/50 Electric Forklift Truck

Basic Load Capacities

RX 60-50 Telescopic mast/single SE tyres

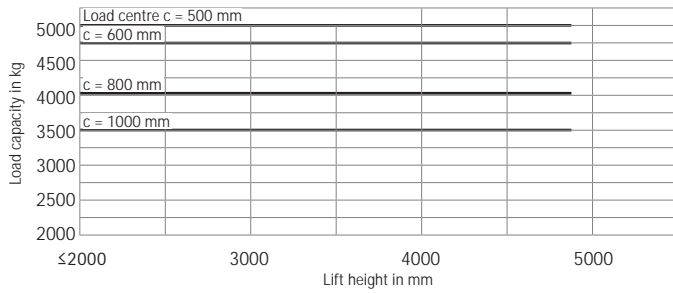

RX 60-50 Triplex mast/single SE tyres

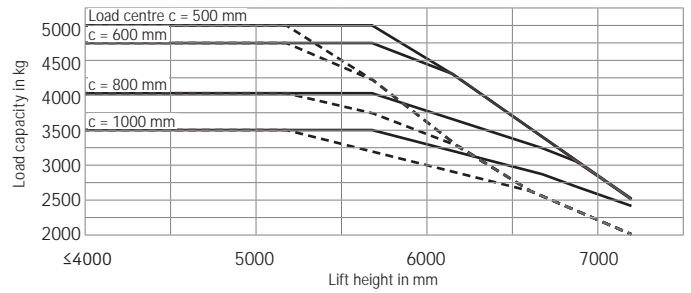

RX 60-50/600 Telescopic mast/single SE tyres

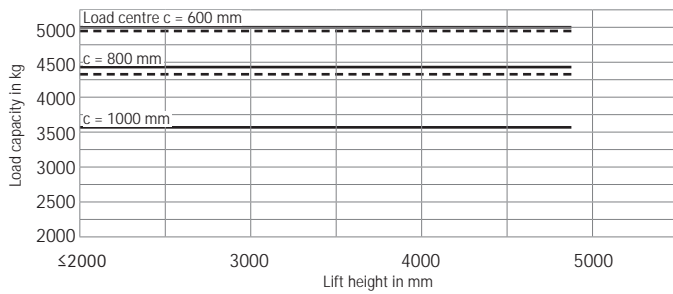

RX 60-50/600 Triplex mast/single SE tyres up to height of 2350 mm

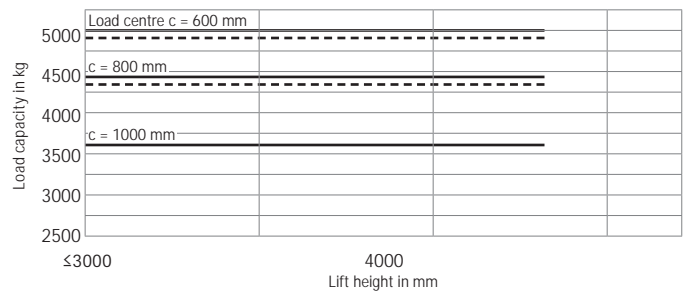

RX 60-50/600 Triplex mast/single SE tyres up to height of 2400 mm

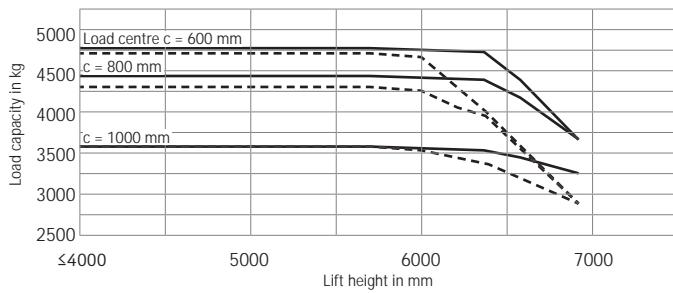

— with standard forks - - - with integrated side shifter and standard forks
 The listed values may vary depending on the truck's features.

RX 60-35/50 Electric Forklift Truck Everything. Except emissions.

Exceptional performance with handling performance at the highest level in its class

Optimal availability: highest range with one battery charge

Ideal workstation: spacious cabin with STILL Easy Control on-board computer



Make the most of the smart performance of an exceptional accelerator. Right from the start the RX 60-35/600 to RX 60-50/600 will win over any operator with its perfect balance of power, ergonomics, manoeuvrability and energy consumption. The 20 km/h intralogistics powerhouse is a true wonder in this segment in terms of the range per battery charge. At the same time, the RX 60-35/600 to RX 60-50/600 impresses with a handling performance at the highest level in the weight class of up to 5.0 tonnes. Moreover, choose our STILL lithium-ion technology and you can even handle three-shift operations without the need for a replacement battery.

Whatever your needs, the RX 60 can be operated intuitively and precisely in any situation. And thanks to the quick-start mode, this nimble truck is ready to start work as soon as you sit down in the spacious driver's cab. Here, you will also find yet another outstanding feature – the STILL Easy Control on-board computer. This tool gives you direct access to key performance functions and provides a constant overview of all the relevant vehicle information. Go electric with a forklift truck that delivers the very best performance every second and in every application.

The 'Simply Efficient' factors: Performance attributes as a measure of economic efficiency



Simply easy

- Intuitive handling: standard, easy-to-use operating concept across the whole RX product line
- Efficiency-enhancing: easy, entry into a highly ergonomic driver's cab
- STILL Easy Control on-board computer: all relevant information at a glance and performance functions just a click away
- Ultra-fast: easy-to-operate lateral battery change



Simply powerful

- Intralogistics powerhouse: handling performance at the highest level in its class
- Performance boost: sprint mode for peak performance at the touch of a button
- Optimum energy efficiency: exceptionally long range with each battery charge
- Lift and accelerate faster than ever: available as a high performance variant with extra-powerful drive and lift motors
- Intelligent support: traction control and other assistance functions
- Ready at all times: optional STILL lithium-ion technology for maximum availability



Simply safe

- Safe and precise handling: high-precision hydraulics and agile driving dynamics
- Safe entry: large handle, anti-slip rubber mat and wide step
- Optimal panoramic view: slim mast and extra-large windows
- Systematic safety: optional pre-shift check on the display to help with the daily safety inspection
- Safety for every application: wide range of additional equipment options – from a direction indicator on the display to the Safety Light 4Plus safety lighting, as well as Curve Speed Control for automatic speed reduction when cornering



Simply flexible

- Flexible control options: multi-lever, mini-lever, Fingertip or Joystick 4Plus
- Adjustable performance dynamics: parameters such as driving and lifting speed can be adjusted to personal preferences at the touch of a button
- Operating power tailored to your specifications: wide variety of equipment options for every application



Simply connected

- Optimum networking: optional interface for integration into fleet management software such as STILL neXXt fleet
- Controlled use: optional access control protects against incorrect operation



STILL GmbH
Berzeliusstr. 10
22113 Hamburg
Germany
Tel.: +49 40 73 39 20 00
Fax: +49 40 73 39 20 01
info@still.de

**For further information please visit
www.still.eu**

STILL is certified in the following areas: Quality management, occupational safety, environmental protection and energy management.



first in intralogistics